

# HINKLEY

L I G H T I N G

Hinkley Lighting  
I.S. 196  
4419

## Instructions for Assembling and Installing Fixtures in the United States

- 1) Install large arms (A) to bottom body of center column (B) with lockwashers (C) and hexnuts (D). Bottom body is the larger one. Tighten hexnuts, a 14mm or 9/16" box wrench is recommended.
- 2) Connect 6 black socket wires to one of the black wires in center column assembly (B) with wire connectors (E). Repeat for other 6 black socket wires. Repeat for 6 white socket wires and one white center column wire. Repeat for other 6 white socket wires. If wires are not black and white, refer to chart for correct connection.

**CAUTION:** Make sure all wires are stripped 5/8" (16mm) and no loose wire strands are outside the connectors. As an added precaution, wire connections should be wrapped with electrical tape.

- 3) Install 1 1/2" long nipple (AA) into hickey (EE) in bottom body. Install large body cover (BB), making sure all wires are located inside bottom body and secure in place with coupling (CC).
- 4) Install medium arms (F) to top body of center column assembly (B) with lockwashers (C) and hexnuts (D). Tighten hexnuts.
- 5) Thread 10" (254mm) nipple (K) into hickey (J) so that 1/4" (6.4mm) is to the inside of the hickey. Thread hexnut (W) onto the nipple on the inside of the hickey and tighten.
- 6) Feed 2 black and 2 white wires through nipple (K) so that 5" (127mm) are in the body.
- 7) Connect 3 black socket wires to one black wire from center column (B) and one black wire from nipple (K) with wire connector (E). Repeat for other 3 black socket wires. Repeat for 3 white socket wires and one white wire from nipple (K). Repeat for other 3 white socket wires. If wires are not black and white, refer to chart for correct connections.

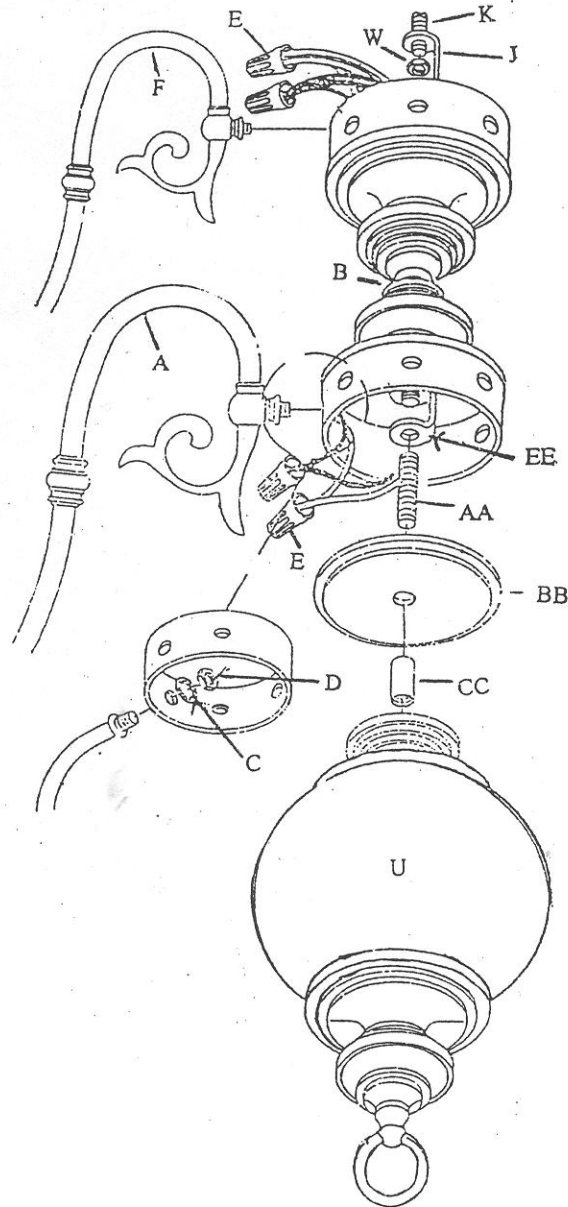

Connect Black or Red House Wire to:	Connect White House Wire to:
Black	White
* Parallel cord (round & smooth)	* Parallel cord (square and ridged)
Clear, Brown, Gold, or Black without tracer	Clear, Brown, Gold, or Black with tracer
Insulated wire (other than green) with copper conductor	Insulated wire (other than green) with silver conductor

Note: When parallel wire (SPT I & SPT II) is used. The tracer wire is square shaped or ridged and the other wire will be round in shape or smooth. (See illus.)

**CAUTION:** Make sure all wires are stripped 5/8" (16mm) and no loose wire strands are outside the connectors. As an added precaution, wire connections should be wrapped with electrical tape.

Date Issued 1/98

(Cont'd on back)

# HINKLEY

L I G H T I N G

## Instructions for Assembling and Installing Fixtures in the United States (Cont'd)

- 8) Position wires inside body and slip body cover (DD) over nipple (K). Position column (M) on body cover (DD).
- 9) Thread nipple (P) into hickey (R) so that 1/4" (6.4mm) is to the inside of the hickey. Thread hexnut (W) onto the nipple on the inside of the hickey and tighten. Install lockwasher (X) onto nipple (P) and thread coupling (H) onto nipple (P) on the outside of hickey (R) and tighten. SEE DETAIL-MAY ALREADY BE ASSEMBLED.
- 10) Position top body (N) on column (M) so that holes for the arms are between the medium arms (F). Thread hickey assembly (R) onto nipple (K) inside body (N) and tighten. Slip lockwasher (X) onto nipple (K) inside hickey (R) and secure in place with hexnut (W).
- 11) Install small arms (S) to top body of center column assembly (M) with lockwashers (C) and hexnuts (D). Tighten hexnuts.
- 12) Feed fixture supply wires through top column assembly (T). Feed fixture supply wires through top coupling/hickey assembly (R) so that 5" (127mm) of wire are in the body.
- 13) Connect black socket wires to black wires from center column (B) and correct fixture supply wire, refer to wire chart for correct connection, with wire connectors (E). Repeat for white wires.

**CAUTION:** Make sure all wires are stripped 5/8" (16mm) and no loose wires strands are inside the connectors. As an added precaution wire connections should be wrapped with electrical tape. Make sure all wires are located inside body and screw bottom ball assembly (U) into place.

**NOW PROCEED WITH FIXTURE HANGING INSTRUCTIONS.**

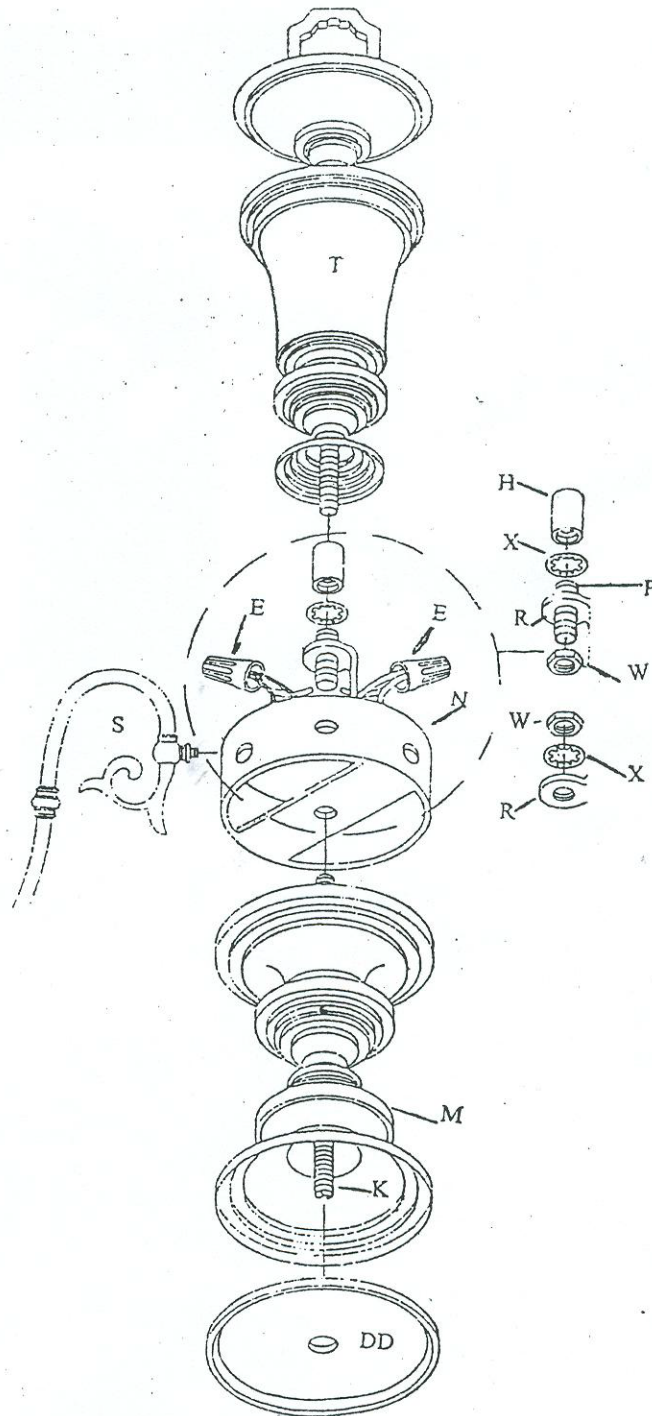

Date Issued: 1/98

Hanging instructions for 3 tier fixture under 50 lbs.

**Drawing 1 - Fixture Assembly**

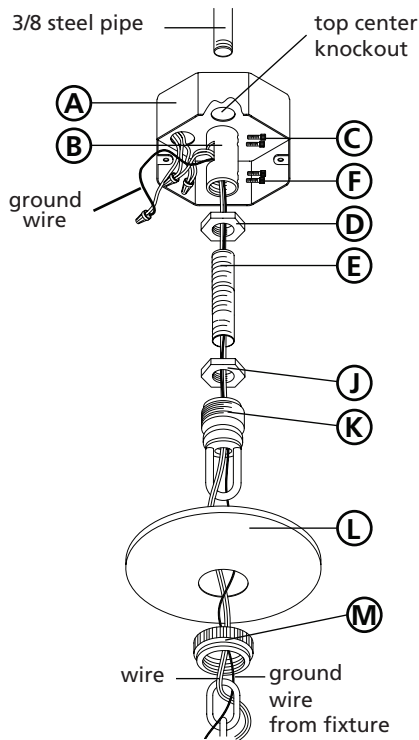

**1**

1. Shut off electrical current before starting. If the fixture you are replacing is turned on and off by a wall switch, simply turn the switch off. If not, remove the appropriate fuse (or open the circuit breakers) until the fixture is dead.

• **DO NOT RESTORE CURRENT - EITHER BY FUSE, BREAKER, OR SWITCH - UNTIL THE NEW FIXTURE IS COMPLETELY WIRED AND IN PLACE.**

2. Supply wires shall enter the outlet box (A) through any knockout EXCEPT the top center knockout - see **Drawing 1**.

**2**

1. Fixture is to be mounted by a 3/8 steel pipe with 3/8 -18 NPSM thread, 3/4" threads at both ends (not supplied). Pipe should be anchored to structure or bridging member with sufficient strength to support 4 times the fixtures weight - see **Drawing 2**.

2. Adjust pipe so 1/2" of 3/8 steel pipe extends into the junction box, at the center knockout.

**3**

1. Thread pipe coupler (B) onto protruding pipe inside outlet box. Secure in place by tightening allen head screw (C) - see **Drawing 1**.

2. Thread hexnut (D) onto threaded nipple (E). Thread nipple (E) into coupler (B). Secure in place by tightening hexnut (D) against coupler (B) and then tightening allen screw (F).

3. Thread hexnut (J) onto nipple (E). DO NOT tighten hexnuts (J) at this time.

4. Thread screw collar loop (K). Adjust loop height so the half of the exterior thread on screw collar loop (K) is exposed when canopy (L) is held up to the ceiling.

**4**

1. Determine length of chain you will require. Attach one end of length of chain to fixture.

2. Slip threaded ring (M) and canopy (L) onto chain - see **Drawing 1**.

3. Attach fixture with chain to screw collar loop (K). Please get assistance, weight and size of fixture is difficult to manage alone.

4. Weave ground wire, and supply wire, through chain, up through center of screw collar loop (K), through center of nipple (E), and out the opening on the side of coupler (B).

5. Make electrical connections from supply wire to fixture lead wires. Refer to instruction sheet (I.S. 18) and follow all instructions to make all necessary wiring connections

6. After connections are made slip wires into junction box. Slip canopy along chain and up to ceiling. Thread thread ring (M) onto loop and tighten to secure canopy to ceiling.

**Drawing 2 - Installation Example**

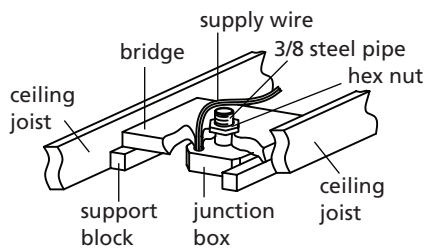

**Drawing 1 - Flush Mount**

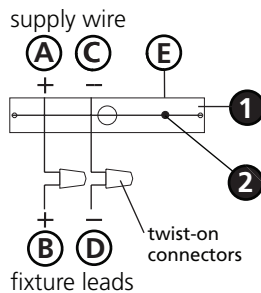

**Drawing 2 - Chain Hung**

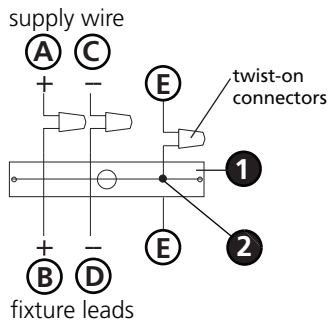

**Drawing 3 - Post-Mount**

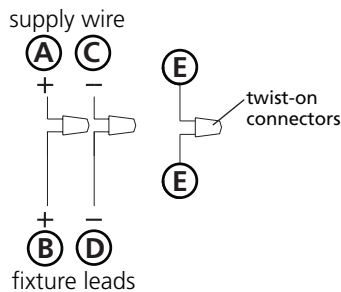

**SAFETY WARNING: READ WIRING AND GROUNDING INSTRUCTIONS (I.S. 18) AND ANY ADDITIONAL DIRECTIONS. TURN POWER SUPPLY OFF DURING INSTALLATION. IF NEW WIRING IS REQUIRED, CONSULT A QUALIFIED ELECTRICIAN OR LOCAL AUTHORITIES FOR CODE REQUIREMENTS.**

### wiring instructions

#### Indoor Fixtures

1. Connect positive supply wire **(A)** (typically black or the smooth, unmarked side of the two-conductor cord) to positive fixture lead **(B)** with appropriately sized twist on connector - see **Drawings 1 or 2**.
2. Connect negative supply wire **(C)** (typically white or the ribbed, marked side of the two-conductor cord) to negative fixture lead **(D)**.
3. Please refer to the **grounding instructions** below to complete all electrical connections.

#### Outdoor Fixtures

1. Connect positive supply wire **(A)** (typically black or the smooth unmarked side of the two-conductor cord) to positive fixture lead **(B)** with appropriately sized twist on connector - see **Drawings 2 or 3**.
2. Connect negative supply wire **(C)** (typically white or the ribbed, marked side of the two-conductor cord) to negative fixture lead **(D)**.
3. Cover open end of connectors with silicone sealant to form a watertight seal.
  - If installing a wall mount fixture, use caulk to seal gaps between the fixture mounting plate (backplate) and the wall. This will help prevent water from entering the outlet box. If the wall surface is lap siding, use caulk and a fixture mounting platform specially.
4. Please refer to the **grounding instructions** below to complete all electrical connections.

### grounding instructions

#### Flush Mount Fixtures

For positive grounding in a 3-wire electrical system, fasten the fixture ground wire **(E)** (typically copper or green plastic coated) to the fixture mounting strap **(1)** with the ground screw **(2)** - see **Drawing 1**.

Note: On straps for screw supported fixtures, first install the two mounting screws in strap. Any remaining tapped hole may be used for the ground screw.

#### Chain Hung Fixtures

Loop fixture ground wire **(E)** (typically copper or green plastic coated) under the head of the ground screw **(2)** on fixture mounting strap **(1)** and connect to the loose end of the fixture ground wire directly to the ground wire of the building system with appropriately sized twist-on connectors - see **Drawing 2**.

#### Post-Mount Fixtures

Connect fixture ground wire **(E)** (typically copper or green plastic coated) to power supply ground with appropriately sized twist-on connector inside post. Cover open end of connector with silicone sealant to form a watertight seal - see **Drawing 3**.